

User manual
Loader scales
Force



LOADRITE Force User manual

Software Number: 60408 Version Number: 2.71

Document Number: MAN-81175-02

Issued Date: June 2015

E: info@loadritescales.com

W: www.loadritescales.com

© 2015 Trimble Loadrite Auckland Ltd. All rights reserved. Trimble, the Globe & Triangle logo are trademarks and/or registered trademarks of Trimble Loadrite Auckland Ltd, registered in the United States and in other countries. Loadrite is a trademark and/or registered trademark of Trimble Loadrite Auckland Ltd. All other trademarks and registrations are the property of their respective owners.





The software contains proprietary information of Trimble Loadrite Auckland Ltd; it is provided under a license agreement containing restrictions on use and disclosure and is also protected by copyright law. Reverse engineering of the software is prohibited.

This document is copyrighted with all rights reserved. Under copyright laws, this document may not be copied in whole or in part, reproduced in any other media, stored in a retrieval system, or transmitted in any form or by any means, electronic, mechanical, photocopying, recording or otherwise, without the express written permission of Trimble Loadrite Auckland Ltd. Permitted copies must carry the same proprietary and copyright notices as were affixed to the original. Under the law, copying includes translation into another language.

Published in New Zealand.

IMPORTANT SAFETY INFORMATION

PLEASE READ CAREFULLY BEFORE USING THE LOADRITE™ WEIGHING SYSTEM

	This is the safety alert symbol. It is used to alert you to potential personal injury hazards. Obey all safety messages that follow this symbol to avoid possible injury or death.
	WARNING indicates a potentially hazardous situation which, if not avoided, could result in death or serious injury.
	CAUTION indicates a potentially hazardous situation which, if not avoided, may result in minor or moderate injury.
	CAUTION used without the safety alert symbol indicates a potentially hazardous situation which, if not avoided, may result in property damage.



It is your sole responsibility to place, secure and use the LOADRITE Weighing System in a manner that will not cause accidents, personal injury or property damage. Always observe safe operating practices.

Do not install the LOADRITE Weighing System in a way that may interfere with the safe operation of the vehicle, or deployment of safety equipment.

Before you use the LOADRITE Weighing System for the first time, familiarize yourself with the system and its operation.



Do not handle the LOADRITE Weighing System if it is hot. Let the product cool, out of direct sunlight.

Ensure that the LOADRITE Weighing System is connected to a power source with the correct fitting and voltage requirements.

Do not attempt to service the LOADRITE Weighing System as this could result in personal injury.



Removing LOADRITE Weighing System equipment or adding accessories could affect the accuracy of weighing data and your warranty.

Do not install cables over horizontal surfaces where they may be stood on or hit by falling objects.

Failure to adhere to these warnings and cautions may lead to death, serious injury or property damage. Trimble Loadrite Auckland Ltd disclaims all liability for installation or use of the LOADRITE Weighing System that causes or contributes to death, injury or property damage, or that violates any law.

TABLE OF CONTENTS

1.	IMPORTANT SAFETY INFORMATION	1-2
2.	WELCOME.....	1-5
3.	INTRODUCTION.....	2-6
	3.1. LOADRITE equipped loader	2-7
	3.2. Indicator features	2-8
	3.3. Accurate weighing.....	2-9
4.	THE DAY-TO-DAY WEIGHING PROCESS	3-10
	4.1. How do I turn on the Indicator?	3-10
	4.2. How do I perform a warm-up?.....	3-10
	4.3. How do I zero the empty bucket?.....	3-10
	4.4. How do I weigh and add a bucket load?	3-11
	4.5. How do I finish the load?.....	3-13
	4.6. How do I put the Indicator into Standby mode?	3-13
5.	READY SCREEN.....	4-14
	5.1. The short and long totals.....	4-15
6.	OPERATION MODES.....	5-17
	6.1. Target Weighing mode.....	5-17
	6.2. Split mode	5-19
7.	ADVANCED WEIGHING – TIP-OFF	6-20
	7.1. Truck tip-off	6-20
	7.2. Stock pile tip-off.....	6-21
8.	PRINTING	7-22
9.	MENU.....	8-23
	9.1. Setup.....	8-23
	9.2. Auto-Add	8-23
	9.3. Scale #	8-24
	9.4. Module	8-24
	9.5. Clock	8-24
	9.6. Display	8-25
	9.7. Long Total	8-26
	9.8. Self test	8-26
	9.9. Uplink	8-26
	9.10. Standby.....	8-26
10.	APPENDIX A: SYSTEM SPECIFICATIONS	9-27
	10.1. Weighing accuracy.....	9-27
	10.2. Minimal weighing delay	9-27
	10.3. Power requirements.....	9-27

10.4. Physical specifications	9-27
10.5. Environmental specifications.....	9-27
10.6. Signal inputs and outputs.....	9-27
10.7. Clock	9-28
10.8. Output/Input connections	9-28
11. APPENDIX B: SPAN CALIBRATION ADJUSTMENT	10-30
11.1. Checking the adjustment.....	10-31
12. APPENDIX C: ERROR MESSAGES.....	11-32
12.1. Bouncing load	11-32
12.2. Bucket not back.....	11-32
12.3. Check power	11-32
12.4. Check MAG/OPT	11-32
12.5. Check rotary.....	11-32
12.6. Check scale#.....	11-32
12.7. Check tilt	11-32
12.8. Check transducer	11-32
12.9. Check zero	11-33
12.10. Lift under range	11-33
12.11. Need emptying	11-33
12.12. No lock	11-33
12.13. Num Attempts Exceeded.....	11-33
12.14. Over target	11-33
12.15. Overload.....	11-33
12.16. Poor lift	11-33
12.17. Printer disabled	11-33
12.18. Printer error	11-33
12.19. Return under range	11-34
12.20. Speed changed	11-34
12.21. Speed too high	11-34
12.22. Tilt too high.....	11-34
12.23. Too heavy, zero aborted	11-34
12.24. Warm-up lift.....	11-34
13. APPENDIX D: GLOSSARY	12-35
14. APPENDIX E: LEGAL INFORMATION	13-37

1. WELCOME

Thank-you for purchasing this LOADRITE Weighing System. Please read this manual carefully before using the Indicator for the first time. Keep this manual in a safe place and use as your first point of reference.

Formatting

The following formatting in this manual identifies specific types of information:

Convention	Type of Information
Bold	<ul style="list-style-type: none">▶ Indicates a button on the Indicator, or▶ Indicates an area displayed on-screen, including buttons, headings, field names and options.
<i>Italics</i>	<ul style="list-style-type: none">▶ Indicates the name of a screen or window, or▶ Indicates an operation mode that the Indicator can be set to.
Monospace	The exact error message displayed on-screen.

Action Terms

The following terms are used throughout this manual to describe actions:

Term	Description
Press	Push and release a button quickly.
Press and hold	Push and hold a button for 2-3 seconds.
Select	Use the arrow buttons to "highlight" an item in a menu or list.

2. INTRODUCTION

The LOADRITE weighing system measures the weight of loads lifted by wheel loaders, forklift trucks and similar machines that use hydraulic rams to lift the load. The main parts of the LOADRITE Weighing System are:

- ▶ the Indicator installed in the cab of the loader, and
- ▶ the connected sensors installed on the lifting arms.

As a load is lifted, the trigger and hydraulic pressure transducers send information to the LOADRITE Indicator. This information is converted into a digital weight reading that is displayed on the LOADRITE Indicator.

The LOADRITE Weighing System can add each lifted load to running totals so that Trucks are loaded accurately and daily productivity levels can be tracked.

The LOADRITE Indicator is the main user interface with the LOADRITE Weighing System.





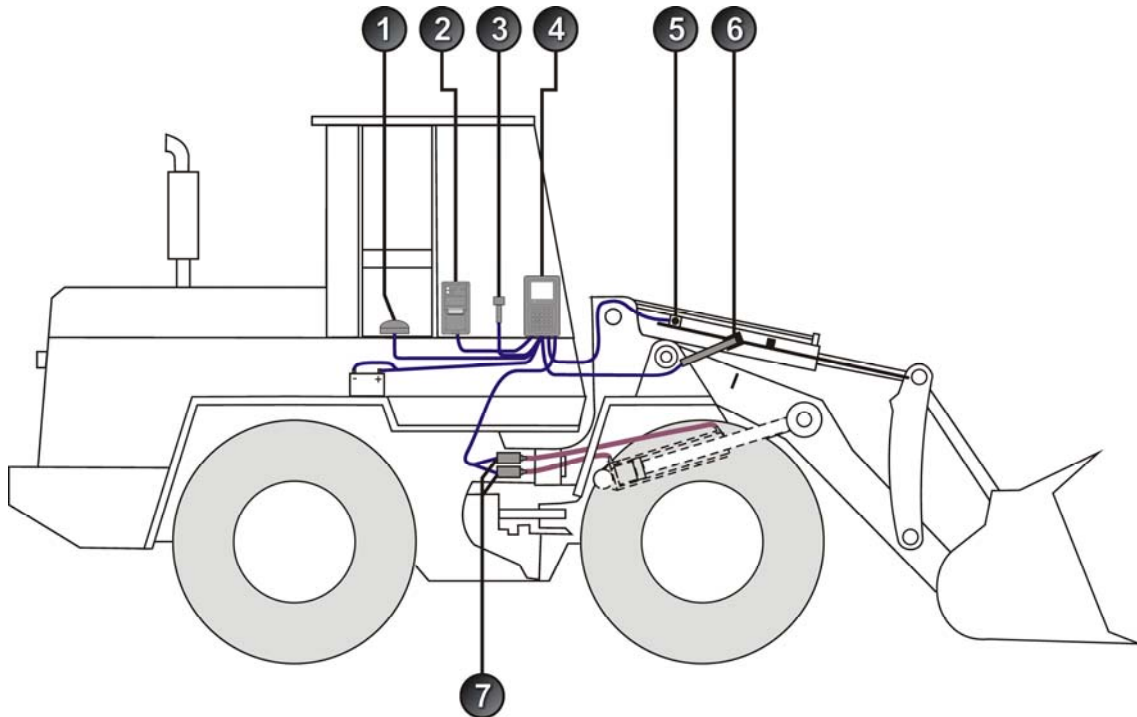









2.1. LOADRITE EQUIPPED LOADER



Item	Description
1	Inclinometer (optional; required for Legal for Trade application)
2	Printer (optional)
3	Remote Add Button (optional)
4	LOADRITE Indicator
5	Interlock Switch (optional; required for Legal for Trade application)
6	Trigger
7	Pressure Transducer

2.2. INDICATOR FEATURES

Icon	Name	Description
	Trigger Light	Illuminates when a load is lifted past the trigger point. When this light is on, the load may be added.
	Menu	Displays the <i>Menu</i> .
	Exit Cancel Standby Mode	<ul style="list-style-type: none"> ▶ Moves back one menu screen. ▶ Cancels changes. ▶ Press and hold for 5 seconds to enter <i>Standby</i> mode.
	Split Mode Down	<ul style="list-style-type: none"> ▶ Activates <i>Split</i> mode weighing. ▶ Moves down a list of options.
	Target Mode Up	<p>Activates <i>Target</i> mode weighing.</p> <p>Moves up a list of options.</p>
	Tip-Off	Activates Tip-off weighing.
	Enter	<ul style="list-style-type: none"> ▶ Selects an item. ▶ Accepts changes.
	Recall Subtract Left	<ul style="list-style-type: none"> ▶ Recalls the last load. ▶ Subtracts the current load from the total. ▶ Scrolls up through values.
	Right	<ul style="list-style-type: none"> ▶ Moves the cursor right, or ▶ Scrolls down through values.
	Add	<ul style="list-style-type: none"> ▶ Adds the current bucket load to the total. ▶ Turn <i>Auto-Add</i> on or off.
	Clear	Clears the short total for the current product.
	Zero Bucket	Zeroes the empty bucket.

2.3. ACCURATE WEIGHING

For maximum accuracy, ensure that:

- ▶ Check Zero is performed regularly.
- ▶ Load lifting motion is steady and smooth, with no acceleration or bounce.
- ▶ The bucket is fully rolled back during the lift.
- ▶ The loader is on level ground.

2.3.1. Obtaining the Best Weighing Results

Lifting speed

For best results, operate the lift lever before accelerating the engine so that the machine does not rock as it lifts, i.e. use normal revs.

Trigger Point

Start the lift well below the Trigger Point. This ensures that all acceleration and load bounce has been eliminated well before the weighing sequence begins.

NOTE: We recommend that there are at least two seconds of lift before the Trigger Point.

Bounce

Most loaders have pneumatic tires which can cause the machine to bounce when lifting.

To minimize the effect of bounce, always operate the lift lever before accelerating the engine and start the lift well below the trigger point.

Center of gravity

The hydraulic pressure in the lifting cylinders depends on where the center of gravity of the load is. It is important that the bucket is always in the same position: fully rolled back.

2.3.2. Legal for Trade Systems

LOADRITE systems meet Legal for Trade requirements in certain countries. This enables material to be weighed and sold directly from the loader.

For more information or to enquire if Legal for Trade is available in your country, contact your LOADRITE distributor.



TIP: Operating requirements for Legal for Trade systems are detailed in this *User manual* where they differ from standard operating requirements.

3. THE DAY-TO-DAY WEIGHING PROCESS

The following is the basic process for day-to-day weighing with the LOADRITE Weighing System:

- 1) Turn on the Indicator.
- 2) Perform a warm-up.
- 3) Zero the empty bucket.
- 4) Weigh and add each bucketload.
- 5) When you have finished loading the truck, clear the short total.
- 6) When you have finished using the LOADRITE Weighing System, put the Indicator into *Standby* mode.

3.1. HOW DO I TURN ON THE INDICATOR?

The LOADRITE Indicator will turn on automatically when you start the loader.

3.2. HOW DO I PERFORM A WARM-UP?

For best weighing accuracy, the hydraulic fluid in the lift cylinders should be at normal operating temperature. This is achieved by raising and lowering the empty bucket.

 Warm Up Lift 3

The above message will display if the Indicator has been turned off for more than one hour. If you see the above message, you need to raise and then lower the empty bucket past the Trigger Point three times:

- 1) Raise the bucket past the Trigger Point.
- 2) Lower the bucket past the Trigger Point.
- 3) Repeat two more times until the message disappears.
When the warm-up has completed, the *Ready* screen will display.

3.3. HOW DO I ZERO THE EMPTY BUCKET?

The *Check Zero* functionality is only available if selected at installation.

It is necessary to periodically "zero" the Indicator because small errors can occur due to a build-up of material in the bucket.

 Check Zero

If you see the above message, you need to zero the empty bucket. The message will display:

- ▶ Every 15 minutes for the first hour, and
- ▶ Every 30 minutes thereafter (the default period is 30 minutes, but it may be set between 15-180 minutes).

Complete the following to zero the bucket:

IMPORTANT: When weighing a load, the loader must be level, and the bucket must be empty and kept fully-rolled back.



- 1) Ensure that the loader is level and the bucket is empty.
- 2) Raise the empty bucket.
- 3) Press .
The **Zero Updated** message will display, before the *Ready* screen is displayed.

3.4. HOW DO I WEIGH AND ADD A BUCKET LOAD?

When the *Ready* screen is displayed, bucketloads can be weighed.

IMPORTANT: When weighing a bucketload, the loader must be level with the bucket kept fully-rolled back.

- 1) Raise the bucketload smoothly past the trigger point using constant engine revs. The **Weighing** message will display.
- 2) The Indicator will beep,  (**Trigger light**) will illuminate and the *Live Weight* screen will display the weight of the current load, the short total and the potential new weight.

Total	
	1.100
	8.100
<hr/>	
9.200	
12:19PM	 1A+ tonne

- 3) Press  to add the load. A message will display the number of buckets added to the current load, for example **Bucket Add #1**.

NOTE: If  is not pressed within 8 (eight) seconds of the load being lifted past the Trigger Point, the Indicator will beep and the **Time Out** message will display. The weight will then be discarded and the *Ready* screen will display. The number of seconds before the Indicator times out may differ, depending on how it was configured during installation.

When the load has been added, the *Ready* screen will display with the new short total and the number of added bucketloads.

3.4.1. Remote Add button

The LOADRITE Weighing System has an optional **Remote Add** button which is normally mounted on or near the lift lever. If the **Remote Add** button is installed in your loader you can use it interchangeably with the button on the Indicator.



3.4.2. Auto-Add

The Auto-Add functionality is only available if enabled at installation. Some features may not be available, depending on your model of LOADRITE Weighing System.

The LOADRITE Weighing System can be set to automatically add a bucket load when lifted past the Trigger Point for a specified number of seconds *OR* when the bucket is rotated forward to tip off the load. This means that you don't need to press  after lifting each load.

Depending on installation setup:



- ▶ Bucket loads may not be added if under a specified amount
- ▶ *Auto-Add* may be turned on or off via the *Setup Menu* or by pressing  (Auto-Add toggle).

3.4.2.1. Auto-Add toggle



The Auto-Add toggle functionality may or may not be available depending the configuration of your Indicator.

You can toggle between using Auto-add and using the normal add process from the *Ready* screen.

Turn Auto-Add on

- 1) From the *Ready* screen, press .
The **Auto-Add On?** message will display.
- 2) Press .
The message will change to **Auto-Add On** and the *Total* screen will display.



Turn Auto-Add off

- 1) From the *Ready* screen, press .
The **Auto-Add Off?** message will display.
- 2) Press .
The message will change to **Auto-Add Off** and the *Ready* screen will display.

3.4.3. Subtract a bucket load

This function can be useful when only part of a final load of loose material is required. Weigh and add a full bucketload, but only tip the amount required into the truck. Then re-weigh and subtract the amount remaining by completing the following:

IMPORTANT: When weighing a bucketload, the loader must be level with the bucket kept fully-rolled back.



- 1) Raise the bucketload smoothly past the Trigger Point.
- 2) The Indicator will beep,  (Trigger light) will illuminate and the weight of the current load, the short total and the potential new weight will display.
- 3) Press .
The **Bucket Subtract** message will display. The amount will be subtracted from the short total. The *Ready* screen will display.

3.4.4. Recall a bucketload



The *Recall* function is equivalent to lifting the same load again and can be used to correct mistakes. The last bucketload can be recalled if it has been added, subtracted or cancelled.

To recall a previously lifted weight, complete the following:

- 1) Press .
The last valid weight that was lifted will be displayed.

Total	
	9.280
	20.220
<hr/>	
	10.940
12:21PM	 1A+ tonne

2) Complete the following:

If...	Then...
the last action was an "add"	press  . The bucketload is subtracted from the short total and long total.
the last action was a "subtract"	press  . The bucketload is added to the short total and long total.

3.5. HOW DO I FINISH THE LOAD?

When you have finished adding bucketloads to the truck, you must clear the short total.

To clear the short total, complete the following:

- ▶ Press and hold .
The short total will display briefly, followed by the **Total Cleared** message, then the *Ready* screen.

For more information on the short total,.





3.6. HOW DO I PUT THE INDICATOR INTO STANDBY MODE?

If you are not going to use the LOADRITE Weighing System for a while, you can put the Indicator into *Standby* mode by completing the following:

Option 1

- ▶ Press and hold  for 5 seconds.
The Indicator will enter *Standby* mode.

Option 2

- 1) Press .
 - 2) Press  or  to scroll up or down until **Standby** is selected, then press .
- The Indicator will enter *Standby* mode.

Option 3

The LOADRITE Indicator will automatically go into *Standby* mode if it is not used for two hours.

How do I exit *Standby* mode?

- ▶ Press any button to exit *Standby* mode.
Either the *Login* screen or *Ready* screen will display.

4. READY SCREEN

The *Ready* screen is the first screen that you will see when you turn on the Indicator. It displays the short total, number of bucketloads and other information.

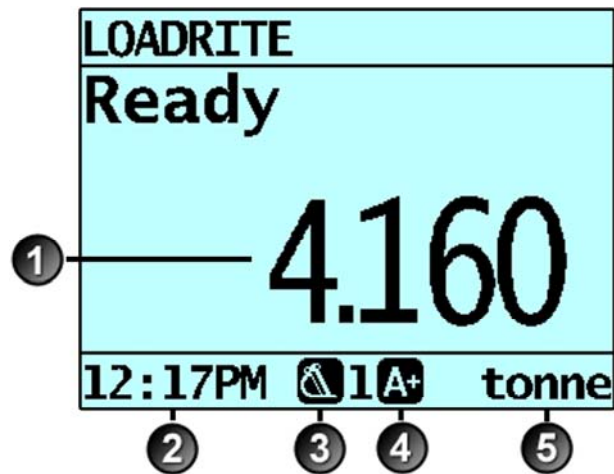

	Component	Description
1	Short total	The current short total of material that has been loaded.
2	Clock	The current time.
3	Weighing implement	The weighing implement being used by the loader.
4	Auto-add	Indicates that the <i>Auto-add</i> functionality is On .
5	Unit of weight	The unit of weight being used. The Short total is displayed in this unit of weight.

4.1. THE SHORT AND LONG TOTALS

The LOADRITE Weighing System keeps a running total of the load weights. Two independent totals are stored - the short total and the long total:

Term	Definition
Short Total	The running total amount of product weighed and loaded onto a truck or carriage. The Short Total amount is displayed on the <i>Ready</i> screen and will continue to accumulate until it is cleared by pressing  .
Long Total	The total amount of product loaded over a long period, such as a work shift or day.

4.1.1. Clear the short total





The short total keeps accumulating until it is cleared. Clear the short total after a load has been completed, for example, after each truck or carriage load.

- ▶ Press .
The short total will display briefly, followed by the **Total Cleared** message, then the *Ready* screen.

NOTE: If the LOADRITE Weighing System has a printer connected, then depending on your installation settings, (i) the totals may be printed before being cleared, or (ii) you may be prompted to print the totals after the **Total Cleared** message is displayed.

4.1.2. View and clear the long total





You can view the long total for the current product at any time.



- 1) Ensure the *Ready* screen is displayed, then press .
- 2) Press  or  to scroll up or down until **Long Total** is selected.
- 3) Press .
The long total will display, followed by the number of buckets added.

Long Total
24.540 tonne

After a few seconds, the Indicator will display the *Ready* screen.

Clear the long total

- 1) Ensure the *Ready* screen is displayed, then press .
- 2) Press  or  to scroll up or down until **Long Total** is selected.
- 3) Press .
The long total for the current product is displayed.
- 4) Press .
The **Long Total Clear?** message will display.

- 5) Press  again to clear the long total.
The **Long Total Cleared** message will display. If the LOADRITE Weighing System has a printer connected, the total will be printed.
- ▶ Press  to cancel the clearing of the long total.
The **Clear Aborted** message will display.

NOTE: If no button is pressed, the clear command will be automatically cancelled.

5. OPERATION MODES

The operation modes that are available depend on the modes selected at installation.

The LOADRITE Indicator can be operated in different modes:

Mode	Description
Total	This is the normal mode of operation. As loads are added, the weights are added to the totals. The short total is displayed.
Target	In this mode, a target weight is entered into the Indicator before loading. As loads are added, the remaining value to reach the target is displayed.
Split	The mode used when loading a multiple train wagons or a truck with multiple trailers where individual totals are required for each individual vehicle. Can be used within <i>Total</i> or <i>Target</i> modes.

5.1. TARGET WEIGHING MODE

Target Weighing mode is only available if selected at installation.

Target Weighing mode provides a simple way to load a truck to a predefined target weight using a series of bucketloads. It is typically used when loading a truck to its optimum payload.

Before loading, the operator enters a target weight value. Each time a bucketload is added, the target value is reduced by that amount.

5.1.1. How do I enter Target mode and input a new target?

1) Press  to clear the previous totals.

2) Press .

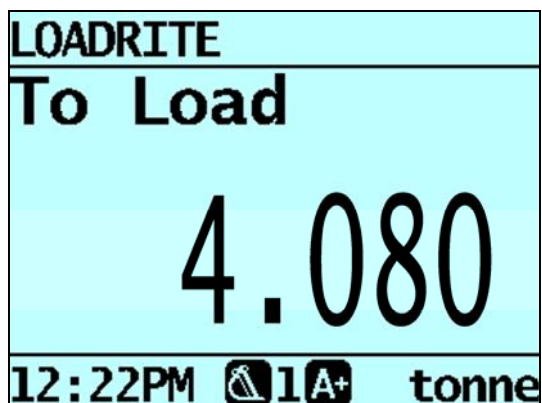

When the **Target?** message is displayed, use  and  to enter the new target amount.

3) Press .
The **Target Updated** message will display briefly, then the *To Load* screen will be displayed.



4) Lift a bucketload.

As you lift a bucketload, the target weight is displayed along with the current lifted weight and the potential weight if the lift is loaded.

Total	
	4.080
	2.260
<hr/>	
1.820	
12:23PM	 1A+ tonne

5) Press  to add the bucketload.

As the truck is loaded, the target amount will decrease.

The aim is to get as close to 0 (zero) as possible. A positive *to load* value is under the target, a negative *to load* value is over the target.



5.1.2. How do I reset the target?

When the load is complete, the target must be reset. This is the equivalent of clearing the short total in *Total* mode.

- ▶ To reset the target, press  .
The **Target Reset** message will display briefly and then the *Target* screen will display.

5.1.3. How do I return to Total mode?

To return to *Total* mode from *Target* mode, the target must be set to 0.

- 1) Press  .
- 2) When the **Target?** message is displayed, press  , then press  .
The *Ready* screen will display.

5.2. SPLIT MODE

Split mode splits the total weight into multiple sub-totals, providing an easy way to load train wagons, or a truck and trailer. *Split* mode is also used to track load distribution over a single vehicle unit, to avoid overloading an axle.

Split mode can be used in conjunction with *Total* or *Target* modes.

Example





A truck with a trailer requires loading. The truck can carry 10,000 tonnes and the trailer 15,000 tonnes, making a total of 25,000 tonnes.

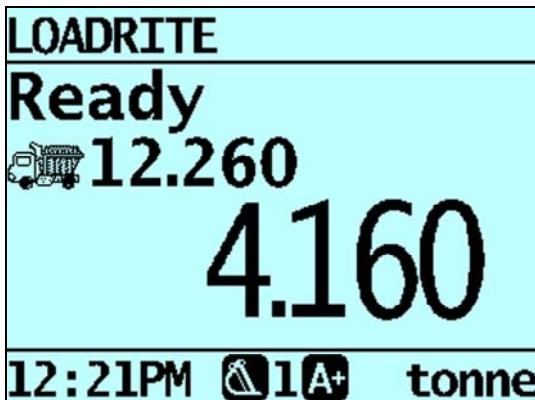

5.2.1. Split mode within Total mode

- 1) In *Total* mode, load the truck with the required amount or product.
- 2) When the required amount of product for the truck is reached, press . The subtotal will briefly display, then the *Split Mode* screen will display. The grand total of the entire vehicle is shown, along with the short total for the trailer:



- 3) Add the required amount of product to the trailer. As each bucketload is lifted, the bucket weight, current trailer weight and total trailer weight will display. Between each lift, the *Split Mode* screen will display showing the new grand total and number of buckets lifted.
- 4) If you would like to split the load to another trailer, press , then go to step 3. Otherwise, continue to step 5.
- 5) When all trailers have been filled, press  to clear the totals.

5.2.2. Split mode within Target mode

- 1) In *Target* mode, enter the target weight for the truck.
- 2) Load the truck with the required amount of product.
- 3) When the required amount of product for the truck is reached, press .
- 4) Press .
- 5) When the **Target?** message is displayed, use the keypad to enter a target weight for the trailer. The *Split* screen will display showing the current target weight for the trailer and the grand total for the entire vehicle.
- 6) Add the required amount of product to the trailer.
- 7) Press  to clear the totals. The *Ready* screen will display.

6. ADVANCED WEIGHING – TIP-OFF

The *Tip-off* functionality is only available if selected at installation.

Tip-off weighing is the adjustment of the final load. It is possible to tip a measured amount of the product out of the last bucket to ensure an exact target weight is reached, where the final load would otherwise exceed the truck's capacity. There are two different methods, depending on the way your LOADRITE Weighing System has been configured:

- ▶ Truck tip-off (default)
- ▶ Stock pile tip-off

Tip-off is only available in *Total* and *Target* modes.

6.1. TRUCK TIP-OFF

Using this method, the operator tips a measured amount of product from the bucket into the truck and dumps the rest.

- 1) Lift the load in the normal way.
The Indicator will display the lifted weight.
- 2) Lift the bucket to a suitable height over the truck, then press .
The **Tip-Off Wait** message will display briefly. Then the screen will display two figures, the amount in the bucket and the short total.



- 3) Roll the bucket partially forward, tipping product into the truck. The Indicator will give a live weight as it is tipped into the truck.

IMPORTANT: Do not raise or lower the lifting arms when tipping, as this will adversely affect the live weight reading. The bucket needs to be rolled back for an accurate weight.

- 4) When the required truck load weight is reached, press .

NOTE: You cannot add a weight while the **Wait...** message is displayed.

- 5) Move the bucket away from the truck and dump any remaining product.

6.2. STOCK PILE TIP-OFF

Using this method, the operator dumps product from the bucket until it contains the right amount for loading onto the truck.

- 1) Lift the load in the normal way.
The Indicator will display the lifted weight.

- 2) Press .
The **Tip-Off Wait** message will display briefly. Then the screen will display the amount in the bucket and the short total.



- 3) Roll the bucket partially forward, dumping the product.
The Indicator will display the weight in the bucket and the potential weight of the truck.

NOTE: Do not raise or lower the lifting arms when tipping, as this will adversely affect the live weight reading. The bucket needs to be rolled back for an accurate weight.

- 4) Keep dumping the product until the desired weight has been reached, then press .

NOTE: You cannot add a weight while the **Wait...** message is displayed.

- 5) Tip the product from the bucket into the truck.

7. PRINTING

Depending on your configuration, various weight data is printed either:





- ▶ when  is pressed at the end of a load, or
- ▶ when , ,  or  is pressed.

The information that is printed depends on settings selected at installation. For further information, contact your LOADRITE distributor.

8. MENU

The *Menu* options that are available depend on options selected at installation.

The *Menu* provides options for configuring the LOADRITE Weighing System.

- ▶ To display the *Menu*, press  twice. Press  or  to scroll up or down, then press  to select an option.
- ▶ To exit the *Menu*, press .

Menu Option	Description
Setup...	Displays the <i>Install Menu</i> . ▶ For further information, contact your LOADRITE distributor.
Auto-Add	Select whether or not Auto-Add is enabled.
Language	Select the language for the Indicator.
Scale#	Select the attachment.
Module	Displays the <i>Data Module</i> screen.
Clock	Displays the <i>Clock</i> screen.
Display	Select the screen backlight and contrast.
Long Tot	Displays the <i>Long Total</i> screen.
Self Test	Runs a system self test
Uplink	Allows the Indicator to communicate with the <i>LOADRITEToolbox</i> PC software
Standby	Puts the Indicator into <i>Standby</i> mode

8.1. SETUP...

The *Install Menu* provides options for configuring the LOADRITE Indicator at installation. A security code is required to access this menu.

- ▶ For further information, contact your LOADRITE distributor.

8.2. AUTO-ADD

The *Auto-Add toggle* functionality may or may not be available depending the configuration of your Indicator.

Controls whether or not the *Auto-Add* functionality is enabled.

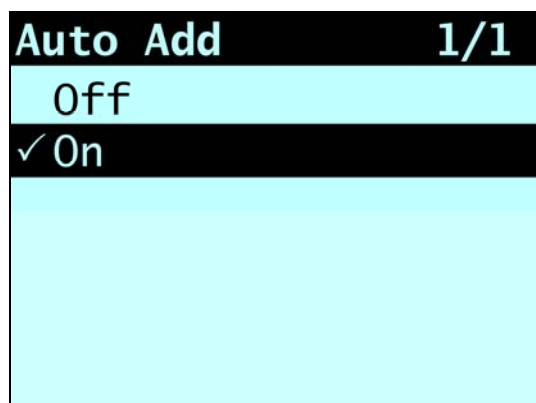

- ▶ Select either **On** or **Off**, then press .

8.3. SCALE

The *Scale* options are only available if *Multiple Scales* functionality has been enabled during installation.

This option enables the use of different load bearing implements (for example, bucket or forks) on the loader. The operator needs to select the correct scale for the attached implement.

TIP: You should perform a *Check Zero* after changing the attachment.

8.4. MODULE

The *Module* option is only available if a LOADRITE Data Module is connected to the Indicator and *Data Logger* functionality has been correctly configured during installation.

The *Data Module Menu* provides functionality for use with LOADRITE Data Modules.

The following menu items are available:

Option	Description
Property	Lists the properties of the Data Module.
Backup	Saves the product list and data lists to the Data Module.
Restore	Uploads data stored on the Data Module to the LOADRITE Indicator. This can be used to share data between Indicators.

8.5. CLOCK



The time, date and year can only be changed if *Clock Edit* functionality has been enabled during installation.

You can set the time, date and year on the Indicator.

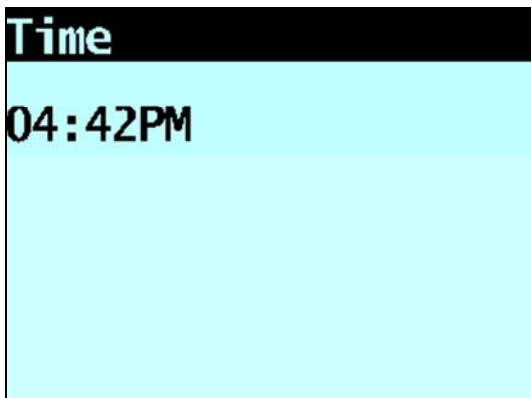

8.5.1. Setting the time

- 1) From the *Clock Menu* select **Time**, then press . The time will display with the cursor over the first digit.





- 2) Use the keypad to enter the time:
 - a. Press  or  to select **AM** or **PM**.
 - b. Press  to confirm the new time.

8.5.2. Setting the date

- 1) From the *Clock Menu* select **Date**, then press .
- 2) Use the keypad to enter the month and day:
 - a. Press **1-9** for **January** to **September**; Press **0** then **0** for **October**; Press **0** then **1** for **November**; Press **0** then **2** for **December**.
 - b. Press  to confirm the new date.

8.5.3. Setting the year





- 1) From the *Clock Menu* select **Year**, then press .
- 2) Use the keypad to enter the last two digits of the year. For example, press **1** then **4** for **2014**.
- 3) Press  to confirm the new year.

8.6. DISPLAY

This option allows the display to be configured. The following menu items are available:





8.6.1. Changing the screen brightness

To change the brightness of the display screen, complete the following:

- 1) From the *Display Menu* select **Light**, then press .
- 2) Press  or  to adjust the backlight brightness up or down.
- 3) Press  to save the brightness level.





8.6.2. Changing the screen contrast

To change the contrast of the display screen, complete the following:

- 1) From the *Display Menu* select **Contrast**, then press .
- 2) Press  or  to adjust the backlight contrast up or down.
- 3) Press  to save the contrast level.

8.6.3. Changing the Target screen layout

There are two layouts available for the *Target* screen. To change the layout, complete the following:

- 1) From the *Display Menu* select **Target**, then press .
- 2) Press  or  to select your preferred *Target* screen layout.
- 3) Press  to save your layout selection.

8.7. LONG TOTAL

View and clear the long total for current products.

- ▶ For more information, (see "View and clear the long total" on page 4-15).

8.8. SELF TEST



This function tests various functions and the internal memory. All tests are run automatically when this option is selected. When the test has completed, the *Ready* screen will display.

8.9. UPLINK



This option is used to upload a configuration file created using *LOADRITE Toolbox* via a LOADRITE Data Module or from a PC via a EDP cable. The configuration file contains product names, data lists and settings.

- ▶ For information on creating a configuration file, refer to the *LOADRITE Toolbox User Manual*.

8.9.1. Uploading a configuration file via a EDP cable

- 1) From the *Uplink Menu* select **EDP**, then press .
The Indicator will enter *Uplink* mode.
- 2) When the message **Uplink Ready** is displayed, use *LOADRITE Toolbox* to send the configuration file.
 - ▶ The message **Updating** and a counter will display as the Indicator receives the configuration file.
 - ▶ *LOADRITE Toolbox* will display a message to indicate that the upload is complete.
- 3) Press  to exit *Uplink* mode.

8.9.2. Uploading a configuration file via a LOADRITE Data Module

- 1) From the *Uplink Menu* select **Data Module**, then press .
- 2) Connect the LOADRITE Data Module containing the configuration file to the Indicator.
- 3) When the **Sync Config From Module?** message displays, press .
A counter will display as the Indicator receives the configuration file.
- 4) When the **Delete Config From Module?** message displays, press .
The configuration file will be deleted from the Data Module.

8.10. STANDBY

This option puts the Indicator into *Standby* mode. The Indicator will also go into *Standby* mode if it is not used for two hours.

- ▶ Press any button to exit *Standby* mode.

9. APPENDIX A: SYSTEM SPECIFICATIONS

9.1. WEIGHING ACCURACY

Typical accuracy is within 1% for most bucket loaders. This may vary with different machine types, installation options, and the operating environment.

9.2. MINIMAL WEIGHING DELAY

Weighing delay is minimal, because the weighing function is carried out during a normal lift.

9.3. POWER REQUIREMENTS

Supply voltage	12 to 32V DC
Supply current	LOADRITE Indicator: 160mA typical, 350mA max. LOADRITE printer: 50mA standby, 4A peak.
Automatic transient suppression	Exceeds relevant SAE specifications for DC automotive power supply transients.

9.4. PHYSICAL SPECIFICATIONS

LCD display	Backlit; 3.8in (diagonal); QVGA.
Tactile keypad	Backlit; Numeric and special functions.
Weight	1.5 kg (3.2lb)
Dimensions	W145 x L240 x D110mm (5.7 x 9.4 x 4.3in)

9.5. ENVIRONMENTAL SPECIFICATIONS

Operating temperature	-10°C ~ 50°C (14°F ~ 122°F)
Storage temperature	-50°C ~ 100°C (-58°F ~ 212°F)
Indicator	Protected to IP54.
Pressure transducer	Protected to IP69.

The Indicator wear-out mechanisms have been evaluated and improved through several iterations of cyclic thermal stress between -90°C and +110°C with simultaneous 6-axis random, repetitive shock exceeding 50Grms.

9.6. SIGNAL INPUTS AND OUTPUTS

Pressure transducer input	4 - 20mA (0-100%)
Trigger	Trigger 1: Magnetic or Optical. Pull-up resistor with switch to ground.
	Trigger 2: Rotary. Pulse width modulated 0-5V.
Serial communications	RS232C protocol to printer and LOADRITE Data Module.

9.7. CLOCK

Built-in clock

Hours, minutes, day, month, year.

9.8. OUTPUT/INPUT CONNECTIONS

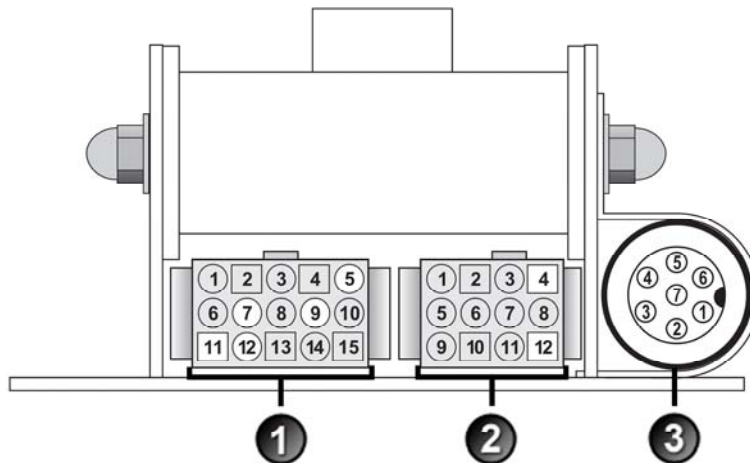

	Connection
1	Power / Control
2	Printer / Data Logger
3	Pressure Transducer

9.8.1. Power / Control

1. Negative supply (ground)	2. Positive supply
3. Remote button 2 (clear)	4. Remote button 1 (add)
5. Tilt sensor 1	6. Tilt sensor 3
7. Tilt sensor 2	8. +VAUX
9. Digital out	10. Boom position
11. Stick position	12. CAN hi
13. CAN lo	14. +V raw
15. Ground output	

9.8.2. Printer / Data Logger

1. Negative supply to printer	2. Positive supply to printer
3. +VAUX	4. RX2
5. TX2	6. Printer RS232 output
7. Printer busy input	8. LOADRITE Data Module RS232 input
9. LOADRITE Data Module RS232 output	10. Ground output
11. Boot	12. N.C.

9.8.3. Pressure Transducer

1. +VAUX	2. Return pressure input
3. Transducer current input	4. +VAUX
5. Lift pressure input	6. Shield
7. Ground	





10. APPENDIX B: SPAN CALIBRATION ADJUSTMENT

This function allows small changes to be made to the LOADRITE Weighing System calibration if the bucket is modified, or if no accurate test weight was available when the LOADRITE Weighing System was calibrated at installation time.

The adjustment is carried out by entering the total weight recorded at a weighbridge (scale house) and the corresponding total provided by the LOADRITE Indicator.

To perform the adjustment, a security access code must be obtained from your LOADRITE installer.

CAUTION The LOADRITE Weighing System alters its calibration every time this function is used. It is important that this function is only used once with a given set of data. If the same weights are entered again, the LOADRITE Weighing System will over-correct and its accuracy will be seriously impaired.

- 1) Press .
- 2) Select **Setup...**, then press .
- 3) Enter the security access code provided by the LOADRITE installer, then press .
- 4) Select **Calibration Menu**, then press .
The *Calibration Menu* will display.
- 5) Select **Adjust Span**, then press .
- 6) The **Adjust Span** message will display briefly and then the *LOADRITE Adjust Span* screen will display.



- 7) Enter the total weight provided by the LOADRITE Indicator, then press .

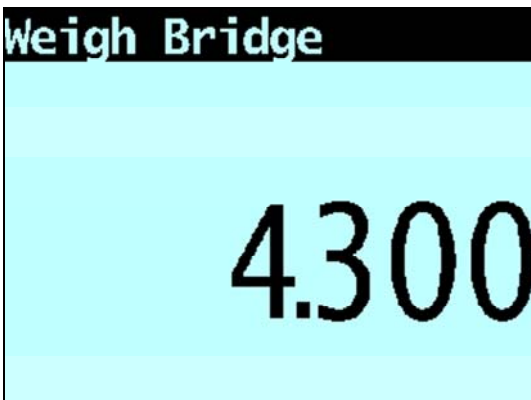

- 8) Enter the total weight provided by the weighbridge, then press .
- 9) The LOADRITE Indicator briefly displays the **Calibration Updated** message, and then returns to the *Calibration Menu*.

10.1. CHECKING THE ADJUSTMENT

The *Span Calibration Adjustment* can be checked by obtaining and comparing new LOADRITE and weighbridge values. If necessary, the *Span Calibration Adjustment* can be performed again using the new data.

IMPORTANT: All trucks and trailers should have tare weights confirmed for all loads to be checked. This ensures that a true weight can be established. Avoid split-weighing the truck and trailer.

11. APPENDIX C: ERROR MESSAGES

Error messages may be displayed for a variety of reasons as detailed below.

11.1. BOUNCING LOAD

If the lift arms are bouncing significantly while weighing, an error occurs. This can happen if, for example, the loader is driven over uneven ground while lifting the load.

Depending on the installation of the particular LOADRITE Weighing System, there are two possibilities:

- ▶ No weight is displayed and therefore there is no weight to add. Repeat the lift.
- ▶ *Weighing Error* is turned off and a weight is displayed. Add the weight to the total (bearing in mind that the weight measurement is not reliable) or ignore this weight and repeat the lift smoothly.

11.2. BUCKET NOT BACK

The bucket must be crowded fully back for each lift. The **Bucket not back** message will be displayed if the LOADRITE Weighing System has not detected that the bucket is fully crowded back.

NOTE: This message should only be displayed when using a Legal for Trade scale.

11.3. CHECK POWER

The power supply has reached an unstable level. Check that the power source is stable and between +12V and +32V.

11.4. CHECK MAG/OPT

There is a fault in the magnetic or optical trigger or the cable that connects the trigger. If using an optical trigger, check that the lens is clear and dust-free.

11.5. CHECK ROTARY

There is a fault in the rotary trigger or the cable that connects the trigger. Check that the trigger is still securely mounted and that the trigger finger has not been damaged.

11.6. CHECK SCALE#

This message displays when  is pressed if the Indicator is set up for use with multiple scales.

If the weight is greater than 10% of full bucket capacity for the selected scale number, the screen displays **Check Scale#** message. The operator needs to ensure the correct scale number is selected for the attached implement, as implements differ considerably in weight.

11.7. CHECK TILT

There is a fault in the tilt sensor used for ground slope compensation or the cable that connects the sensor. Check that the tilt sensor is still securely mounted and that the cable has not been damaged.

11.8. CHECK TRANSDUCER

There is an error in the pressure transducer signal input. This indicates a fault in either the pressure transducer or the cable that connects the transducer.

11.9. CHECK ZERO

The operator is automatically reminded to zero the bucket.

11.10. LIFT UNDER RANGE

The lift pressure was too low. This indicates a fault in either the pressure transducer or the cable that connects the transducer.

11.11. NEED EMPTYING

The bucket must be crowd fully forward to ensure that all product has been emptied. The **Need Emptying** message will be displayed if the LOADRITE Weighing System has not detected that the bucket has been crowd fully forward.

NOTE: This message should only be displayed when using a Legal for Trade scale.

11.12. NO LOCK

The interlock was not closed when lifting the load. The interlock must be closed (or the bucket must be fully rolled back) while lifting the load. No weight is displayed and therefore there is no weight to add.

11.13. NUM ATTEMPTS EXCEEDED

This message displays if the number of attempts to perform a check zero is exceeded when FACT is activated. The number of attempts is set during installation.

11.14. OVER TARGET

Adding the lifted weight will exceed the target value. The lifted weight can still be added by pressing .

NOTE: The *Auto-add* function will not automatically add over-target weight.

11.15. OVERLOAD

The lifted weight exceeds the full scale (capacity) setting. If the *Overload Error* is set during installation, overloaded weight cannot be added.

11.16. POOR LIFT

If a weighing error is close to, but not greater than, the tolerance limit, the LOADRITE Indicator displays this warning message. The weight can be added as usual.

11.17. PRINTER DISABLED

Print function has been disabled at installation.

11.18. PRINTER ERROR

There is a fault in the printer. Check that the printer is online and has paper.

11.19. RETURN UNDER RANGE

The return pressure was too low. This indicates a fault in either the pressure transducer or the cable that connects the transducer.

11.20. SPEED CHANGED

For accurate measurement, the speed of raising the lift arms must be smooth, without acceleration or deceleration. The LOADRITE Weighing System can detect changing speed as the arms go past the Trigger Point. Depending on the installation of the LOADRITE Weighing System, there are two possibilities:

- ▶ No weight is displayed, and therefore there is no weight to add. Repeat the lift and avoid accelerating and decelerating at or near the Trigger Point.
- ▶ A weight is displayed. Add weight to the total (acknowledging that the weight measurement is not reliable) or ignore this weight and repeat the lift smoothly.

11.21. SPEED TOO HIGH

This message displays if the speed of raising the arms is too fast and exceeds predefined limits.

Lift the arms again slower. If the message displays again, there may be a fault in the system. The LOADRITE Weighing System should be checked and, if necessary, re-calibrated.

11.22. TILT TOO HIGH

The angle of the loader is at an unsafe roll or pitch while weighing. The **Tilt Too High** message accompanies the specific roll or pitch error at the top bar of the display.

11.23. TOO HEAVY, ZERO ABORTED

If the weight of product in the bucket is greater than 10% of full bucket capacity when  is pressed, the screen displays this message and does not alter any settings. This prevents any accidental zeroing of valid weights.

NOTE: If the bucket is empty and the message still occurs, there may be a fault in the system. The LOADRITE Weighing System should be checked and, if necessary, re-calibrated.

11.24. WARM-UP LIFT

This message displays if the LOADRITE Indicator has been turned off for more than one hour, prompting a warm-up lift.

12. APPENDIX D: GLOSSARY

A

Auto-add

Automatically adds the lifted weight to the total weight every time a load is lifted.

B

Bucket

The attachment on the loader that holds the bulk product/material or load while it is being transferred.

C

Check Zero

The message displayed periodically to remind the operator to use the *Zero* function to set the weight of the bucket to **0**.

- ▶ See also *Zero/Zeroing*.

D

Data Module

A memory device which connects to the Indicator to store payload and related data. The Data Module can then be connected to a PC running MMS software to transfer the data for the creation of productivity reports.

Display

A screen with adjustable backlighting for night and low-light operations. Used to display weight information and messages.

Docket

A printed record of a load.

- ▶ May also be known as *Ticket*.

I

Indicator

The LOADRITE user interface installed in a loader or excavator which the operator uses to record bucket weights. When used with a belt scale, the term *Integrator* should be used.

NOTE: May also be known as *Console, Module, In-Cab Console, Loadrite, Loadrite Console, Head Unit, Clock, Computer, Scale*; however *Indicator* is the preferred term.

Interlock

Sensors which detect the back and forward positions of the bucket. Can be used in *Legal for Trade* software, where the bucket must be fully rolled back for weighing and rolled forward for emptying.

- ▶ See also *Legal For Trade*.

L

Legal for Trade

Certification by a local weights and measures authority to legally sell product from your loader or other scale.

Load

The amount of product added to a truck, or the act of adding product to a truck.

Loader

The heavy equipment machine or vehicle that is primarily used to load product onto a vehicle such as a truck, hopper, rail-car, etc.

- ▶ May also be known as a *front-end loader, loading machine, loading vehicle, wheel loader*, etc.

LOADRITE Weighing System

Refers to the entire LOADRITE hardware and software weighing system installed at a site, including the Indicator, transducers, sensors, modem, InsightHQ software, etc.

Long Total

The total amount of product loaded over a long period, such as a shift or day.

- ▶ See also *Short Total*.

M

Modem

A device used to transfer live payload and other data from the Indicator to InsightHQ. The modem may be a cellular modem (for example, LOADRITE Communications Controller modem), or a radio modem.

O

Operation Mode

Any mode that relates to the running total of accumulated weights, for example, *Total* or *Target* mode.

Operator

The person operating the loader.

- ▶ Also known as *Loader Driver* or *Loader Operator*.

P

Pressure Transducer

A pressure sensor connected to the loader's hydraulic system in order to measure the hydraulic pressure required to lift a load.

Printer

An optional accessory mounted in the loader cab. It provides a paper record of the weighing information collected by the Indicator.

- ▶ See also *Docket* or *Ticket*.

Product

Substance that comprises a load. For example, salt, coal, rock, etc.

R

Remote-Add Button

An additional **Add** button which is mounted in close proximity to the loader controls and performs the same function as the **Add** button on the LOADRITE Indicator. The button enables the operator to add a load without having to remove their hands from the loader controls.

S

Short Total

The running total amount of product loaded onto a truck or carriage. The Short Total amount will continue to accumulate until it is cleared using the *Clear* function.

Split Mode

The mode used when loading a truck with multiple trailers where individual totals are required for the truck and each individual trailer.

Standby

A low-power mode which the Indicator should be set to between jobs, for example, when the operator is moving the loader and does not need to weigh a load.

T

Target Mode

A mode used to enter a predetermined product target weight. The Indicator will calculate and display the amount of product required to reach the target. For each lift, the lift weight will be subtracted from the displayed amount until the target weight is reached.

Ticket

A printed record of a load.

- ▶ May also be known as *Docket*.

Tip-off

The final bucket load adjustment, which allows you to tip a measured amount of the product from the final bucket to ensure an exact target weight is reached.

Transducer

- ▶ See *Pressure transducer*.

Trigger

A sensor which responds to the position of the lift arms, and informs the Indicator when to take a weight reading. LOADRITE weighing systems have three types of trigger: optical, rotary and magnetic.

Trigger Point

A point (or series of points) in the position of the lift arms where a weight reading is taken.

W

Weighbridge

A platform scale for weighing vehicles.

- ▶ Also known as *Ground Scale*, *Scale House* and *Truck Scale*.

Z

Zero/Zeroing

Sets the weight of the bucket to **0**. Zeroing is required to reset the weight of the bucket from time-to-time. This is to avoid inaccurate readings due to the build-up of material in the bucket which can occur when operators are dealing with wet or sticky materials.

- ▶ See also *Check zero*.

13. APPENDIX E: LEGAL INFORMATION

Disclaimer

Trimble Loadrite Auckland Ltd operates a policy of on-going development. Please note that while every effort has been made to ensure that the data given in this document is accurate, due to continued product development, the information, figures, illustrations, tables, specifications, and schematics contained herein are subject to change without notice. Trimble Loadrite Auckland Ltd does not warrant that this document is error-free. The screenshots and other presentations shown in this manual may differ from the actual screens and presentations generated by the actual product. All such differences are minor and the actual product will deliver the described functionality as presented in this document in all material respects. If you find any errors in the document, please report them to us in writing.

Trimble Loadrite Auckland Ltd assumes no liability in connection with the use of any LOADRITE branded product.

Trimble Loadrite Auckland Ltd is not responsible for any radio or TV interference caused by unauthorized modifications to this equipment. Such modifications could void the user's authority to operate the equipment.

Compliance

Domain	Applicable Standard
Immunity Standards (industrial)	IEC 61000-4-3 (ed1.2) Electromagnetic compatibility (EMC) - Part 4-3: Testing and measurement techniques - Radiated, radio-frequency, electromagnetic field immunity test (80% 1kHz Amplitude Modulated) from 80MHz to 1GHz 10V/m IEC 61000-4-3 (ed1.3) Electromagnetic compatibility (EMC) - Part 4-3: Testing and measurement techniques - Radiated, radio-frequency, electromagnetic field immunity test (80% 1kHz Amplitude Modulated) from 1.4GHz to 2GHz 3V/m IEC 61000-4-3 (ed1.4) Electromagnetic compatibility (EMC) - Part 4-3: Testing and measurement techniques - Radiated, radio-frequency, electromagnetic field immunity test (80% 1kHz Amplitude Modulated) from 2GHz to 2.7GHz 1V/m
Conducted	IEC 61000-4-6 (ed2.1) Electromagnetic compatibility (EMC) - Part 4-6: Testing and measurement techniques - Immunity to conducted disturbances, induced by radio-frequency fields
Fast Transients	IEC 61000-4-4 (ed2.1) Electromagnetic compatibility (EMC) - Part 4-4: Testing and measurement techniques - Electrical fast transient/burst immunity test +/-1KV (5/50 Tr/Th ns - 5kHz repetition)
ESD	IEC 61000-4-2 Electromagnetic compatibility (EMC) - Part 4-2: Testing and measurement techniques - Electrostatic discharge immunity test +/-4kV / Electrostatic Air Discharge +/-8kV
Electromagnetic compatibility (EMC)	EN/IEC/ASNZS 61000-6-2:2005 Electromagnetic compatibility (EMC) - Part 6-2: Generic standards - Immunity for industrial environments EN/IEC 61000-6-4:2005 Electromagnetic compatibility (EMC) - Part 6-4: Generic Standards - Emission standard for industrial environments ANSI C63.4:2003 FCC Part 15 (A and B) - Radio Frequency Devices



Products with the CE marking comply with the Electromagnetic Compatibility Directive (2004/108/EC) issued by the Commission of the European Community. Compliance with this directives implies conformity to the following European Standards:

EN 61000-6-2:2005 Electromagnetic compatibility (EMC) - Part 6-2: Generic standards - Immunity for industrial environments

EN 61000-6-4:2005 Electromagnetic compatibility (EMC) - Part 6-4: Generic Standards - Emission standard for industrial environments

This LOADRITE product is fully EMC (Electro-Magnetic Compatibility) compliant and is CE marked accordingly. A Declaration of Conformity, in accordance with the EMC Directive 89/336/EEC (and as amended) is available from Trimble Loadrite Auckland Ltd on request: info@loadritescales.com

Trimble Loadrite Auckland Ltd cannot be held responsible for modifications made by the User and the consequences thereof, which may alter the conformity of the product with CE marking.

Hereby, Trimble Loadrite Auckland Ltd, declares that this LOADRITE Force is in compliance with the essential requirements and other relevant provisions of Directive 2004/108/EC.

This LOADRITE product is explicitly excluded from the scope of EU RoHS 2 Directive 2011/65/EU in article 2, section (4), paragraphs: (d), (e), (f) and (g).

This device complies with part 15 of the FCC Rules and Industry Canada licence-exempt RSS standard(s). Operation is subject to the following two conditions: (1) This device may not cause harmful interference, and (2) this device must accept any interference received, including interference that may cause undesired operation.

This Class A digital apparatus complies with Canadian ICES-003 (A) / NMB-003 (A).

WARNING: This product contains chemicals known to the State of California to cause cancer, birth defects or other reproductive harm. This Notice is being provided in accordance with California's Proposition 65.

Disposing of LOADRITE electronic equipment

This electronic product is subject to the EU Directive 2002/96/EC for Waste Electrical and Electronic Equipment (WEEE) which requires the separate collection, treatment, recycling and environmentally-sound final disposal of waste of electrical and electronic equipment. As such, this product must not be disposed of at a municipal waste collection point.

Please refer to local regulations for directions on how to dispose of this product in an environmentally-friendly manner.



NOTES

MAN-81175-02